

PVP-Series Biotube® Pump Vaults

Applications

Orenco's patent-pending PVP-Series Biotube Pump Vaults are for use with Orenco 4in (100mm) submersible effluent pumps. PVP-Series Pump Vaults are ideal for all types of wastewater treatment systems, such as liquid-only sewers and on-site treatment systems. These vaults house one or two Orenco high-head effluent pumps and can be used in single-compartment septic tanks with flows up to 40gpm (2.5L/sec). For flows exceeding this rate, a double-compartment septic tank or separate dosing tank is recommended.



PVP-Series Pump Vault, cross-sectional side view

General

The Orenco PVP-Series Biotube Pump Vault includes a molded polyethylene housing and an internal Biotube Filter Cartridge constructed of polypropylene and PVC. The pump vault keeps sludge and scum away from the filter, pump, and float switches, while the filter removes particles 1/8in (3.2mm) or larger from the tank's clear zone. This reduces suspended solids by two-thirds, on average, and allows clear effluent to be discharged (see [Filter Facts Fact Sheet, AFS-FI-1](#)). The passively self-cleaning design extends maintenance cycle intervals. The filter cartridge can be removed without pulling the pump or the vault. PVP-Series Vaults can accommodate one or two high-head effluent pumps.

Product Code Diagram

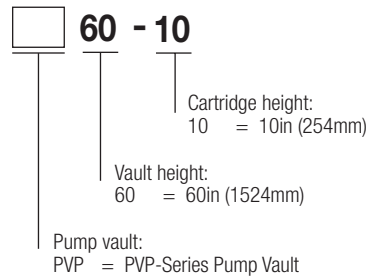

Tank Access and Riser Diameters

Diameter, in (mm)	PVP (simplex pump)	PVP (duplex pumps)
Tank access, min.	18 (457)	18 (457)
Tank access, max.	20 (508)	24 (600)*
Riser, min.	24 (600)	30 (750)

*An extension kit, product code PVP-AEK, is required for tank access openings larger than 19in (483mm) in 30in (750mm) risers.

Pump Vault

Orenco's patent-pending PVP-Series Biotube Pump Vault is designed to be passively self-cleaning for reduced maintenance and service needs.

Materials of Construction

Vault body	Polyethylene
------------	--------------

Dimensions, in (mm)

A	22 (559)
B	16.63 (422)
C	60 (1524)
D Inlet height	10.88 (276)
E Lowest float switch setting point	31 (787)
F	2 (51)

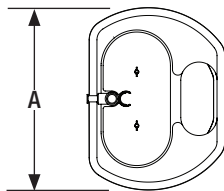

PVP-Series Pump Vault, top view

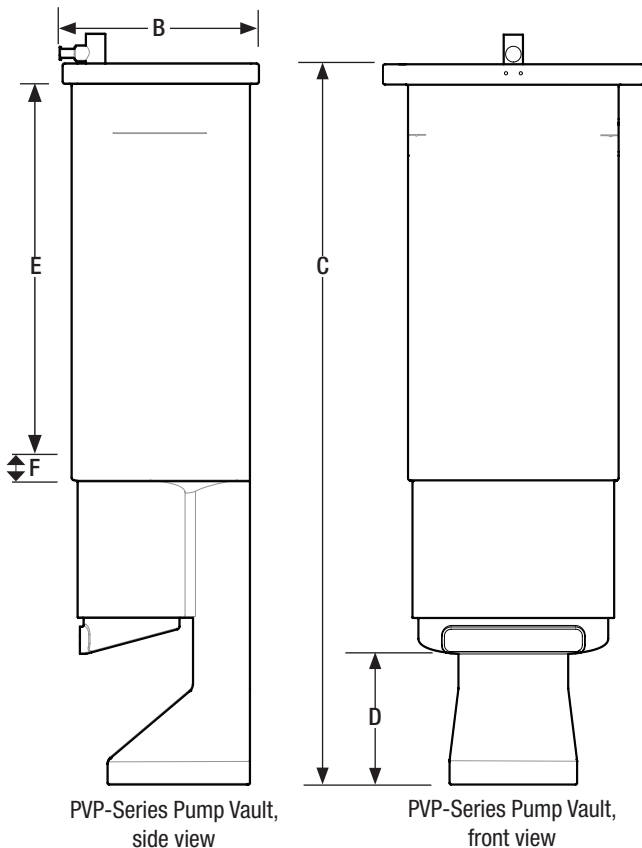

PVP-Series Pump Vault, side view

PVP-Series Pump Vault, front view

Biotube Filter

The Orenco PVP-Series Biotube Filter is designed for effective filtration of effluent and passive self-cleaning for long cleaning intervals.

Materials of Construction

End plates	Dicyclopentadiene (DCPD)
Filter tubes	Polypropylene
Handle assembly	Sch. 40 PVC
Screws	Stainless steel

Dimensions, in (mm)

A	16.50 (419)
B	10 (254)

Performance

Biotube mesh, in (mm)*	0.125 (3)
Total filter flow area, ft ² (m ²)	4 (0.37)
Total filter surface area, ft ² (m ²)	14 (1.3)

*0.062in (1.6mm) filter mesh available

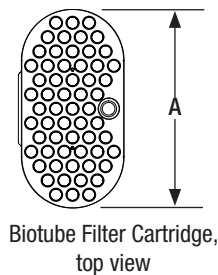

Biotube Filter Cartridge, top view

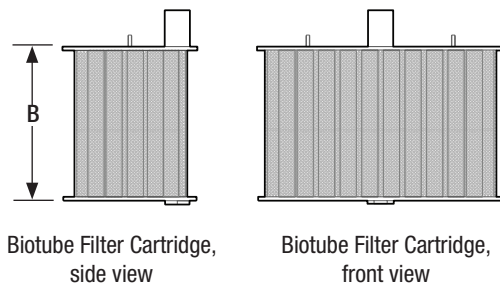

Biotube Filter Cartridge, side view

Biotube Filter Cartridge, front view

Pump Vault Adapter Extension Kit

The Orenco PVP-Series Biotube Pump Vault Adapter Extension Kit is required when using a 30in (750mm) riser with an access opening larger than 19in (483mm). The kit contains two brackets, six nuts, and six bolts.

Materials of Construction

Support brackets	Fiber-reinforced polymer (FRP)
Nuts and bolts	Stainless steel

Dimensions, in (mm)

A	14 (356)
B	6.5 (165)
C	5.5 (127)
D	27.9 (709)

Product Code Diagram

PVP - AEK

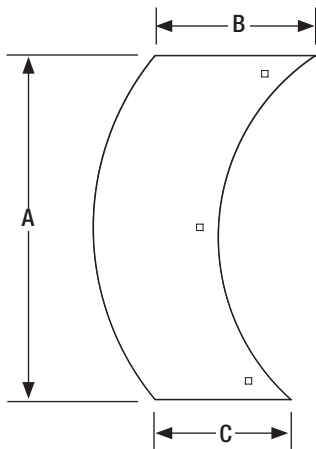
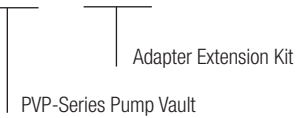

Single bracket from adapter kit

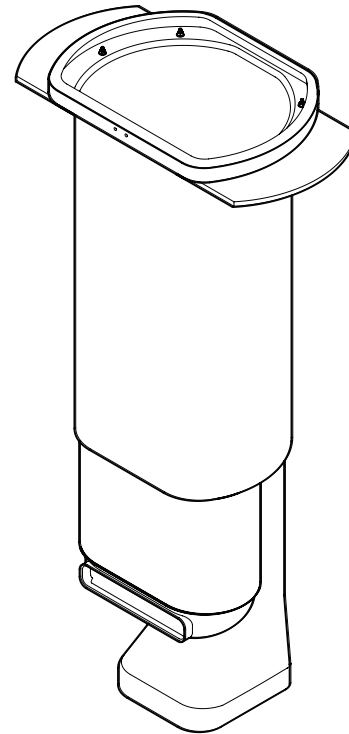

Adapter kit installed, isometric view

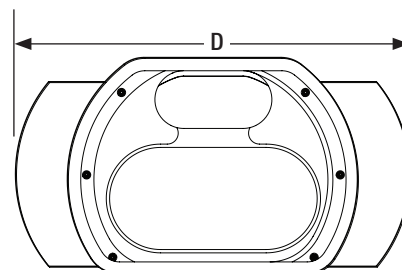

Adapter kit installed, top view