

Orenco Prelos® 1000 Processor

Applications

Orenco's Prelos 1000 Processor provides complete, integrated storage, filtration, and pumping of wastewater for on-lot portions of Prelos Sewer systems and other pressurized liquid-only sewers or dispersal systems.

General

The Prelos Processor is the core of the Prelos Sewer System: an innovative technology based on 40 years of proven sewer solutions. The tank stores and passively treats solid waste, while the patent-pending pump vault and filter separate and pump liquid effluent.*

All Prelos 1000 Processors install as a unit, to reduce errors. The 30in (750mm) diameter access riser provides easy access to the tank interior, and the passively self-cleaning filter can be removed without removing the pump vault, pump, or discharge assembly, simplifying O&M and keeping related costs down.

* Tank covered under United States Patent #10,392,281

Standard Model

PRELOS1000-18, PRELOS1000-24, PRELOS1000-30, PRELOS1000-36, PRELOS1000-48, PRELOS1000-60

Product Code Diagram

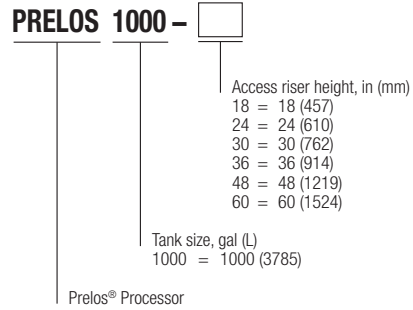

The Prelos 1000 Processor offers complete, integrated storage and pumping of wastewater in a simple, effective package.

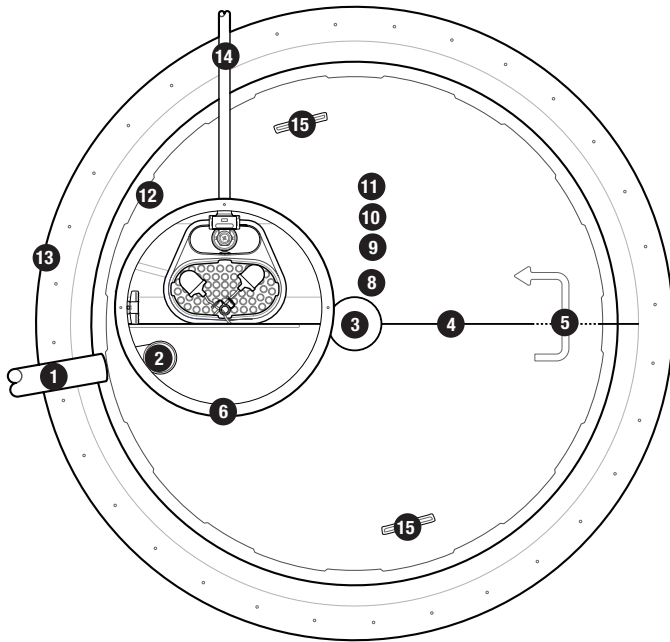
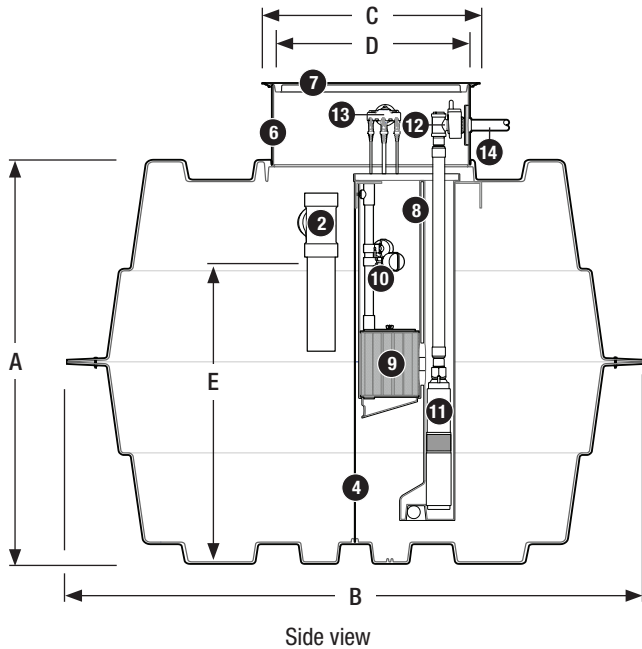

- | | | |
|------------------------------|---------------------------|------------------------|
| 1. Inlet | 6. Access riser | 11. Pump |
| 2. Inlet tee | 7. Access lid | 12. Discharge assembly |
| 3. Support column | 8. Pump vault | 13. ClickTight™ |
| 4. Baffle wall (full-length) | 9. Biotube® filter | 14. Discharge |
| 5. Baffle pass-through | 10. Float switch assembly | 15. Lifting bracket |

Tank, Riser, and Lid

The Prelos 1000 Processor's meander-style tank has a patented design for superior performance. It's tough, impact resistant, and light enough to install with small equipment. The single 30in (750mm) access riser and access lid are designed to provide strong, secure access to components inside of the Prelos 1000 Processor.

Materials of Construction

Access lid	Fiber-reinforced polymer (FRP), structural foam
Access lid hardware	Stainless steel
Access riser	FRP
Inlet and inlet tee	ABS
Baffle wall	ABS
Support column	PVC, ABS
Tank body	DCPD

Dimensions

A	Tank height, in (mm)	61 (1549)
B	Tank outside diameter, in (mm)	96 (2438)
C	Lid outside diameter, in (mm)	33 (838)
D	Riser inside diameter, in (mm)	29.5 (749)
E	Depth, nominal operating volume, in (mm)	48 (1219)
	Tank nominal operating volume, gal (L)	1000 (3785)
	Tank total volume, gal (L)	1220 (4618)
	Average volume at operating depth, gal/in (L/mm)	20 (3)
	Prelos Processor weight, nominal, lbs (kg)	550-640 (250-290)

Pump Vault

The Prelos 1000 Processor's patent-pending pump vault is designed to be passively self cleaning for reduced maintenance and service needs, with no need to remove the vault from the processor for cleaning.

Materials of Construction

Vault body	Polyethylene
------------	--------------

Vault Dimensions in (mm)

A	18.5 (470)
B	16.0 (406)
C	52.5 (1334)
D	15.75 (400)

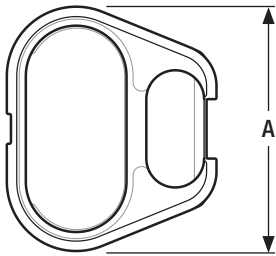

Prelos pump vault, top view

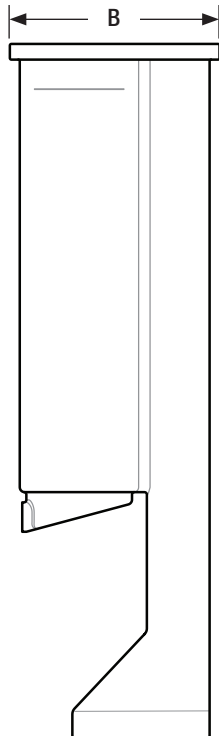

Prelos pump vault, side-cutaway view

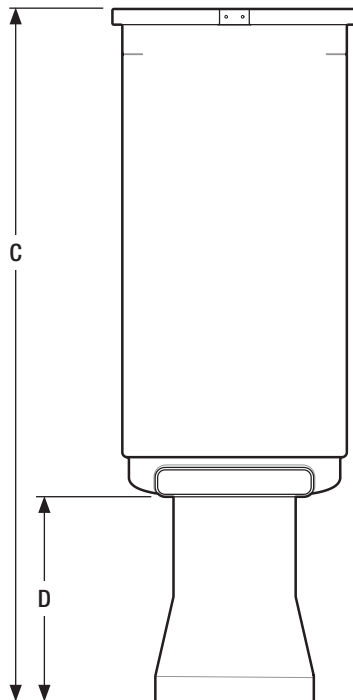

Prelos pump vault, front view

Biotube Effluent Filter

The Prelos 1000 Processor's Biotube effluent filter is designed for effective filtration of effluent and passive self cleaning for long maintenance cycle intervals.

Materials of Construction

End plates	DCPD
Filter tubes	Polypropylene
Handle assembly	Sch. 40 PVC
Screws	Stainless steel

Dimensions in (mm)

A	16.5 (419)
B	10.0 (254)

Performance

Biotube mesh opening, in (mm)*	0.125 (3)
Total filter flow area, ft ² (m ²)	4.0 (0.37)
Total filter surface area, ft ² (m ²)	14.0 (1.3)

*0.062in (1.6mm) filter mesh available

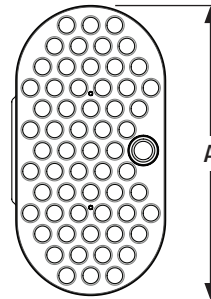

Biotube filter cartridge, top view

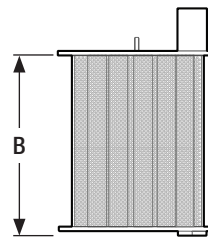

Biotube filter cartridge, side view

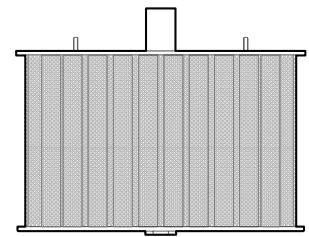

Biotube filter cartridge, front view

4in (100mm) Effluent Pump

Pumps used in Prelos 1000 Processors are Orenco's PF-Series pumps. They're field serviceable with common tools and, in internal testing, have a minimum 24hr run-dry capability (liquid end) with no deterioration in pump life or performance. These pumps are equipped with Type SOOW 600V power cords (suitable for Class I, Division 1 and 2 applications); they also meet UL requirements and are CSA certified to US and Canadian safety standards for effluent pumps.

Materials of Construction

Connector	Glass-filled thermoplastic, silicone
Diffusers	Glass-filled PPO
Discharge	Glass-filled polypropylene
Discharge bearing	Engineered thermoplastic (PEEK)
Impellers	Acetal
Intake screens	Polypropylene
Lubricant	Deionized water, propylene glycol
Suction connection, drive shaft, coupling, shell	Stainless steel

Specifications

Nominal flow, gpm (L/sec)	10 (0.6)
Length, in (mm)	23 (584)
Weight, lb (kg)	26 (12)
Discharge, in (nominal)	1.25
Impellers	6

Performance

hp (kW)	0.5 (0.37)
Design flow amps	12.7
Rated cycles/day	300
Minimum liquid level, in (mm)*	16 (406)

* Minimum liquid level is for a single pump installed in a pump vault.

Pump Curve

This graph shows the pump's performance range and the relationship between flow (gpm) and pressure (TDH).

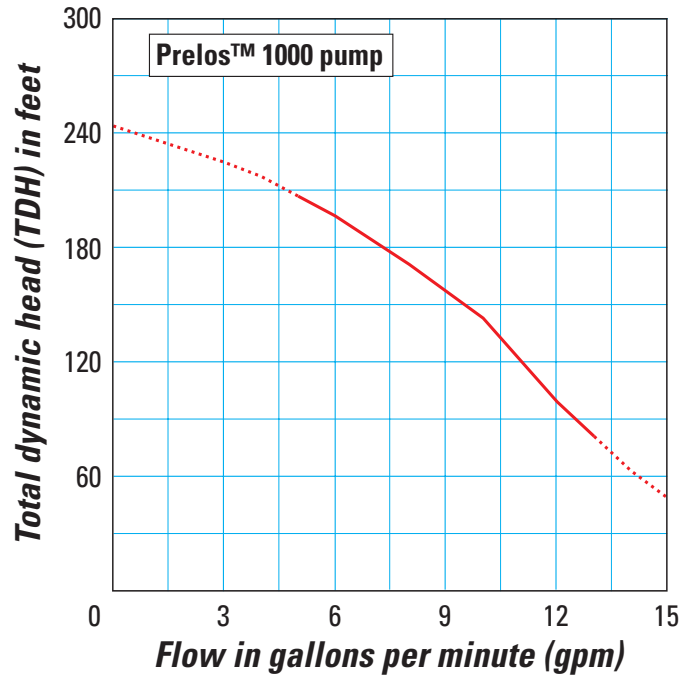

HDA-Series Discharge Assembly

Discharge assemblies used in Prelos 1000 Processors are designed for durability and ease of maintenance.

Materials of Construction

Anti-siphon valve	Sch. 80 PVC, EPDM, stainless steel
Discharge nipple	Sch. 80 PVC
Flexible hose	Reinforced EPDM
Flow control disc	Sch. 80 PVC
Hose fittings, tee fitting, mounting screws	Stainless steel
In-line check valve	Sch. 80 PVC, EPDM, stainless steel
Mounting plate	ABS
Quick-disconnect	Glass-filled thermoplastic

Working Pressures and Dimensions

Unit working pressure, psi (kPa)	150 (1034)
Height, mounting plate, in (mm)	7 (178)
Width, mounting plate, in (mm)	7 (178)
Diameter, discharge nipple, in*	1.25
Diameter, flow control disc orifice, in (mm)	0.25 (6.35)

* Contact your Orenco distributor about fittings to connect discharge assemblies to metric-sized piping.

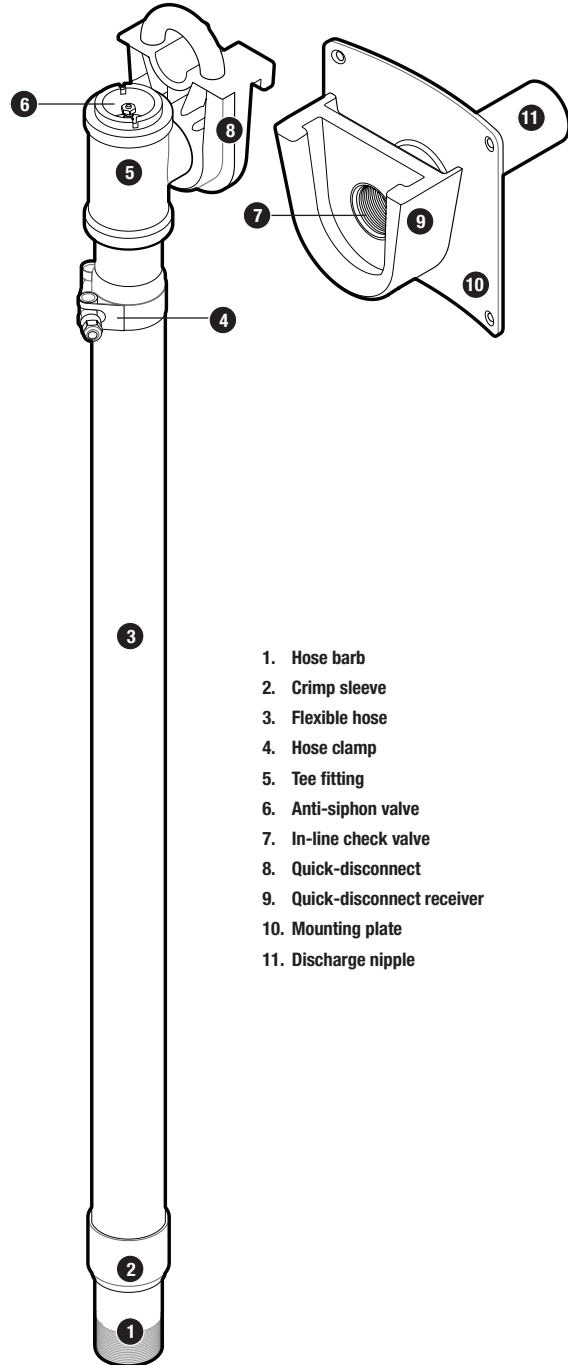

1. Hose barb
2. Crimp sleeve
3. Flexible hose
4. Hose clamp
5. Tee fitting
6. Anti-siphon valve
7. In-line check valve
8. Quick-disconnect
9. Quick-disconnect receiver
10. Mounting plate
11. Discharge nipple

HDA-Series discharge assembly

Float Switches

Float switches used in Prelos 1000 Processors are UL listed and CSA certified for use in water or sewage. To simplify accessing and servicing, the float switch assembly has been incorporated into the Biotube filter handle.

Materials of Construction

ClickTight connector	Glass-filled thermoplastic, silicone
Float collar	ABS
Float cord	Flexible, 2 conductor (UL, CSA, SJOW; CPE cord jacket with EPDM insulated conductors)
Float housing	Impact-resistant, noncorrosive polypropylene for use in liquids up to 140°F (60°C)

Float Switch Specifications

Float	State	Type
P	Normally open	Mechanical

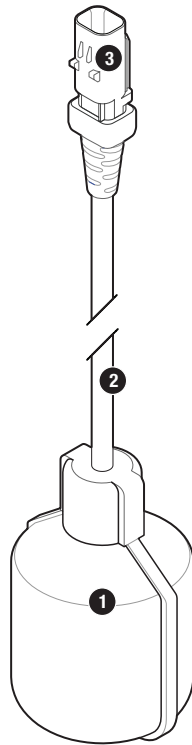
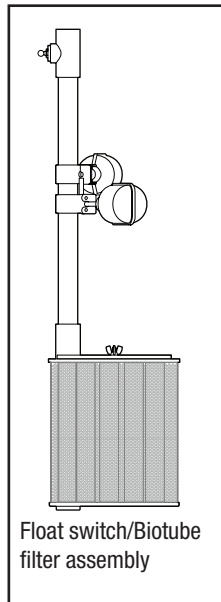

1. Float switch
2. Float switch cord
3. Float switch connector

ClickTight mechanical float switch

ClickTight

Orenco's ClickTight provides secure, moisture-resistant cable connections between the pump, float switches, and control panel in the Prelos 1000 Processor. ClickTight is UL listed for the US and Canada.

Materials of Construction

Cable	PVC/nylon, annealed copper; Type TC
Connectors	Glass-filled thermoplastic, silicone
Fastener	Stainless steel
Housing	ABS
O-ring	Buna-N
Potting compound	Urethane

Specifications

Cable rating	14AWG; 3 conductor; UL TC-ER 600V (pump) 18AWG; 2-8 conductor; UL TC-ER 600V (float)
Float switch connectors	double-pole
Pump connector	triple-pole
Maximum cable length, ft (m)	62 (19)

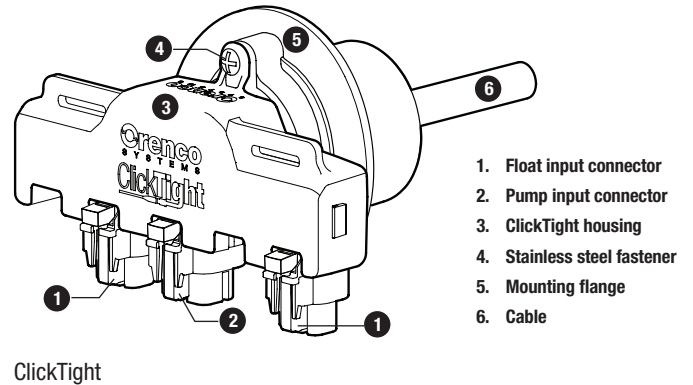

S1HR Control Panel

The Prelos 1000 Processor uses Orenco's S1HR control panel, which is ideal for Prelos Sewers and other effluent sewer applications.

Materials of Construction

Enclosure	UV-resistant fiberglass, UL Type 4X
Hinges	Stainless steel

Dimensions, in (mm)

Height	11.5 (292)
Width	9.3 (236)
Depth	5.4 (137)

Specifications

Panel ratings	120VAC, 1hp (0.75kW), 16A, single-phase, 60Hz
Motor-start contactor	16FLA, 1hp (0.75kW), 60Hz; 2.5 million cycles at FLA
Circuit breakers	120VAC, 10A, single-pole (control) 120VAC, 20A, single-pole (pump)
Toggle switch	Single-pole, double-throw HOA switch
Audio alarm	95dB at 24in (610mm), warble-tone sound; gasketed, UL Type 4X (IP 66)
Redundant high-on relay	120VAC, DIN rail mounted; provides a secondary pump-on signal during high-level conditions
Audio alarm silence relay	120VAC, automatic reset, DIN rail mount
Visual alarm	7/8in (22mm) diameter red lens, "push-to-silence," 120VAC LED, UL Type 4X

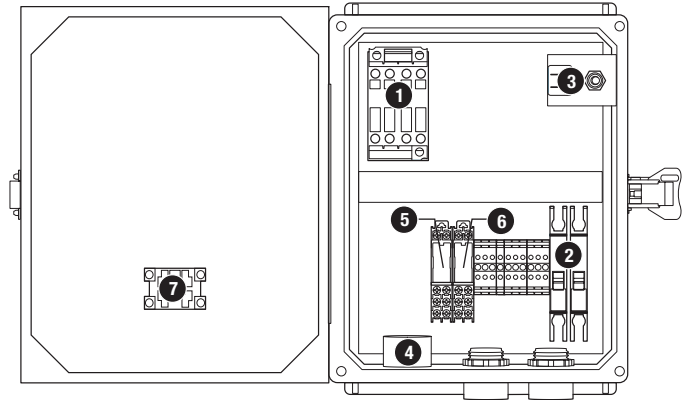

S1HR control panel

1. Motor-start contactor
2. Circuit breakers
3. Toggle switch
4. Audio alarm
5. Redundant high-on relay
6. Audio alarm silence relay
7. Visual alarm